



# CFE-5100

## Residential ESS Manual

### About CFE-5100 ESS

CFE-5100 ESS can be installed in Parallel and Series mode, more attention should be paid for the DIP and address selection following with part 5.3.2.

### About this Manual

The Manual is intended for the CFE-5100 Residential ESS, but the hybrid inverter and any other equipment is not included.

# Contents

1 Safety Instructions.....	3
1.1 Important Safety Instructions.....	3
1.2 Warnings In This Document.....	3
1.3 Battery Handling Guide.....	3
1.4 Response To Emergency Situations.....	3
1.4.1 Leaking Batteries .....	4
1.4.2 Fire.....	4
1.4.3 Wet Battery .....	4
1.4.4 Damaged Battery .....	4
1.5 Installers.....	5
1.6 Scrap Battery .....	5
1.7 Customer Careline .....	5
2 Product Introduction.....	5
2.1 Technical Data .....	5
2.2 Exploded Views Of Battery .....	6
2.3 Indicator And Ports.....	7
2.4 Communication Interface Plat (Dvc-A <sub>2</sub> Voltage) .....	7
2.5 How It Works.....	8
2.6 Feature .....	8
3 Guidance For Disconnection Of Batteries During Shipment .....	9
4 Installation Prerequisites.....	9
4.1 Installation Location.....	9
4.2 Installation Process .....	10
4.3 Installation Materials.....	11
4.4 Tools .....	12
4.5 Safety Instruments .....	12
4.6 Network Cable .....	12
4.7 Storage.....	13

5 Battery Installation .....	13
5.1 Package Items.....	13
5.2 Checks before Installation.....	14
5.3 Installation The Battery .....	14
5.3.1 Connect With 51.2vdc Inverter.....	15
5.3.1.1 Wall Mounting.....	15
5.3.1.2 Ground Installation.....	16
5.3.2 Address Selection of Master and Slave Battery(les) Connection.....	16
5.4 Cable Connections .....	19
5.4.1.1 Ground Installation.....	19
5.4.1.2 Wall Mounting.....	21
5.4.2 Cable Connection for Parallel Connection .....	21
6 Configuration .....	22
6.1 Configure Device Wifi.....	22
6.2 Register Your Account.....	24
6.3 Settings For Can /485 Bus Pins .....	25
7 Commissioning .....	25
7.1 Commissioning Battery .....	26
7.2 Shutting Down Battery .....	26
8 Troubleshooting .....	26
9 Firmware Update.....	28

## 1 Safety Instructions

### 1.1 Important Safety Instructions

This manual contains important instructions for:







#### CFE-5100 Residential ESS product (“Product”)

This manual must be followed when installing and using this Product.

The Product is designed and tested in accordance with international safety requirements IEC 60364, but as with all electrical and electronic equipment, certain precautions must be observed when installing and/or operating the Product. To reduce the risk of personal injury and ensure the safe installation and operation of the Product, you must carefully read and follow all instructions, cautions, and warnings in this manual.

### 1.2 Warnings in this Document

A warning describes a hazard to equipment or personnel. It calls attention to a procedure or practice, which, if not correctly performed or adhered to, could result in damage to or destruction of part or all of the CFE equipment and/or other equipment connected to the CFE equipment or personal injury.

Symbol	Description
	Caution, risk of electric shock
	Heavy enough may cause severe injury
	Keep the battery away from open flame or ignition sources
	Keep the battery away from children
	Do not dispose of the Product with household waste
	Recycling
	Read this manual before installation and operation

For safety reasons, installers are responsible for familiarizing themselves with the contents of this manual and all warnings before performing installation.

### 1.3 Battery Handling Guide

Use the battery pack only as directed.

### 1.4 Response to Emergency Situations

The CFE Residential ESS is designed with multiple safety strategies to prevent hazards resulting from failures. However, CFE cannot guarantee their absolute

safety for uncertain situations.

#### 1.4.1 Leaking Batteries

If the battery pack leaks electrolyte, avoid contact with the leaking liquid or gas. Electrolyte is corrosive and contact may cause skin irritation and chemical burns. If one is exposed to the leaked substance, do these actions:

**Inhalation:** Evacuate the contaminated area, and seek medical attention immediately.

**Eyes contact:** Rinse eyes with flowing water for 15 minutes, and seek medical attention immediately.

**Skin contact:** Wash the affected area thoroughly with soap and water, and seek medical attention immediately.

**Ingestion:** Induce vomiting as soon as possible, and seek medical attention immediately.

#### 1.4.2 Fire

In case of a fire, make sure that an ABC or carbon dioxide extinguisher is nearby and does not use water to extinguish the fire.

#### WARNING

The battery pack may catch fire when heated above 130°C.  
If a fire breaks out where the battery is installed, do these actions:  
1) Extinguish the fire before the battery catches fire.  
2) If the battery has caught fire, do not try to extinguish the fire.  
Evacuate people immediately  
If the battery catches fire, it will produce poisonous gases. Do not approach.

#### 1.4.3 Wet Battery

If the battery is wet or submerged in water, do not try to access it. Contact CFE customer careline or your distributor for technical assistance.

#### 1.4.4 Damaged Battery

If the battery is damaged, please contract CFE customer careline or your distributor for help as soon as possible, because damaged battery is dangerous and must be handled with extreme caution. Damaged battery is not suitable for use and may pose a danger to people or property. If the battery seems to be damaged, return it to CFE or your distributor.

#### CAUTION

Damaged battery might export electrolyte or flammable gas, so contact CFE for advice and information immediately. we will deal

with it within 48h.

## 1.5 Installers

CFE Energy Storage battery is suggested to be installed by a skilled worker or an electrician. A skilled worker is defined as person who is a trained and qualified electrician or possesses all of the following skills and experience:

- ✓ Knowledge of the functional principles and operation of on-grid energy Storage systems.
- ✓ Knowledge of the dangers and risks associated with installing and using electrical devices and acceptable mitigation methods.
- ✓ Knowledge of the installation of electrical devices
- ✓ Knowledge of and adherence to this manual and all safety precautions and best practices.

## 1.6 Scrap Battery

For scrap batteries, please dispose according to local laws or regulations on recycling.

## 1.7 Customer careline

Use the contacts below for technical assistance. This phone number is available only during business hours on weekdays.

Customer careline	+86 400 996 8377
-------------------	------------------

## 2 Product Introduction

### 2.1 Technical data

Model	CFE-5100
Total Energy*	5.1kWh
Effective Energy(d.c)*	4.8kWh
Nominal Charge/Discharge Power	3Kw
Voltage	48V-56Vdc
Nominal Voltage	51.2Vdc
Nominal Current	60A
Max. Charge Voltage	57.6V
Recommended DOD	90%
Peak power (only discharging)	6.0KW for 3 sec.
Operating Condition	Indoor
Operating Temperature (Charge)	0~50°C

Operating Temperature	-10~55°C
Dimensions(mm)	442*500*133
Weight	51Kg
Relative Humidity(R H)	20~60%(No condensed water)
Cooling Type	Ambient cooling
Case Material	Metal
Color	Black
Installation	Cabinet or Wall Mounting
IP Rating	IP20
Protective Class	I
Max. Number of Parallel	8
Max. Number of Tandem	8
Warranty	10Years
Communication	CAN/RS485
Protection Mode	Triple Hardware Protection
Battery Protection	Over-Current/Over-Voltage/Short Circuit/
Safety Certificate	CE & TUV(IEC 62619, IEC 62040)
Hanzrd Class of Dangerous Goods	9
Transportation	UN38.3

- ✧ Testing Conditions Based on Temperature 25°C at The Beginning of Life.
- ✧ Total Energy/Usable Energy Measured Under Specific Conditions From CFE 0.2C CC/CV

## 2.2 Exploded views of battery

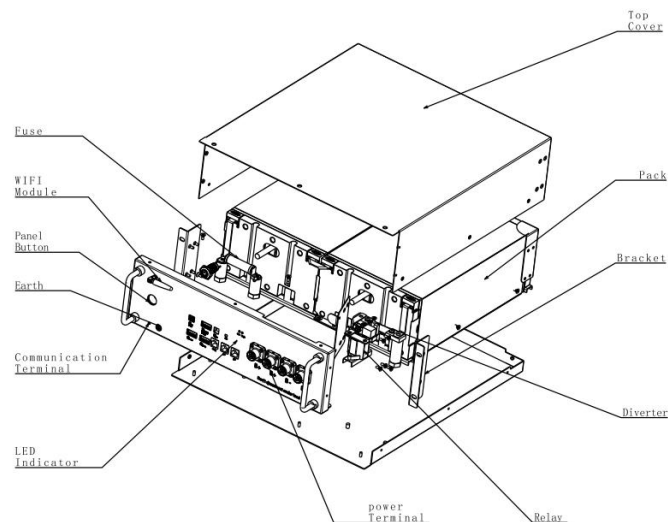

## 2.3 Indicator and ports

There are two LED indicators on the front of the battery to show its operating status.

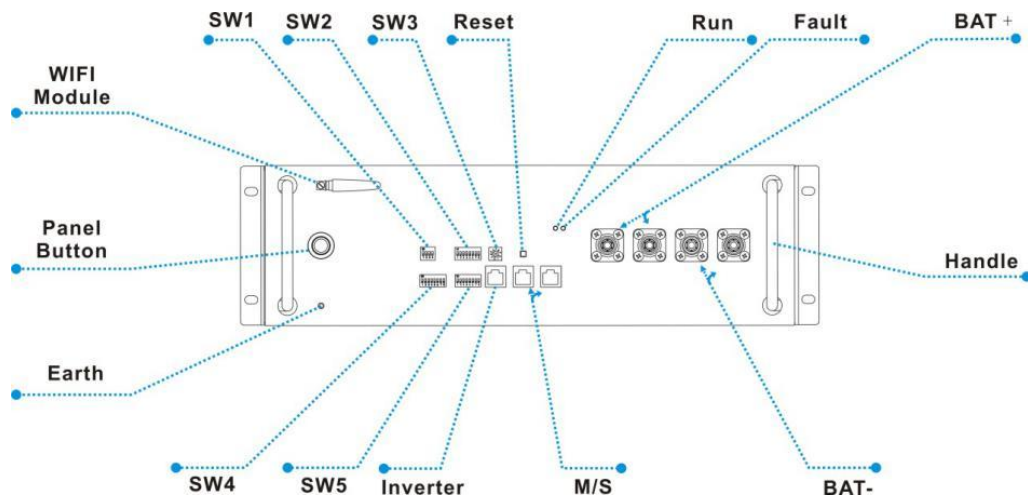

Table 2-1 Designations on the battery

Item	Designation	Definition
1	Running	Battery normally working without fault
2	Fault	Battery is in a warning state, see troubleshooting in Chapter

## 2.4 Communication interface plat (DVC-A<sub>2</sub> voltage)



SW1	DIP switch select for CAN or RS485
SW2	Resistance for communication and DIP switch for parallel connection
SW3	Switch for battery's Address select
SW4 & SW5	Communication interface for battery or master battery with Inverter
Reset	Reset the WIFI or GPPS/GPS module configuration



## 2.5 How it works

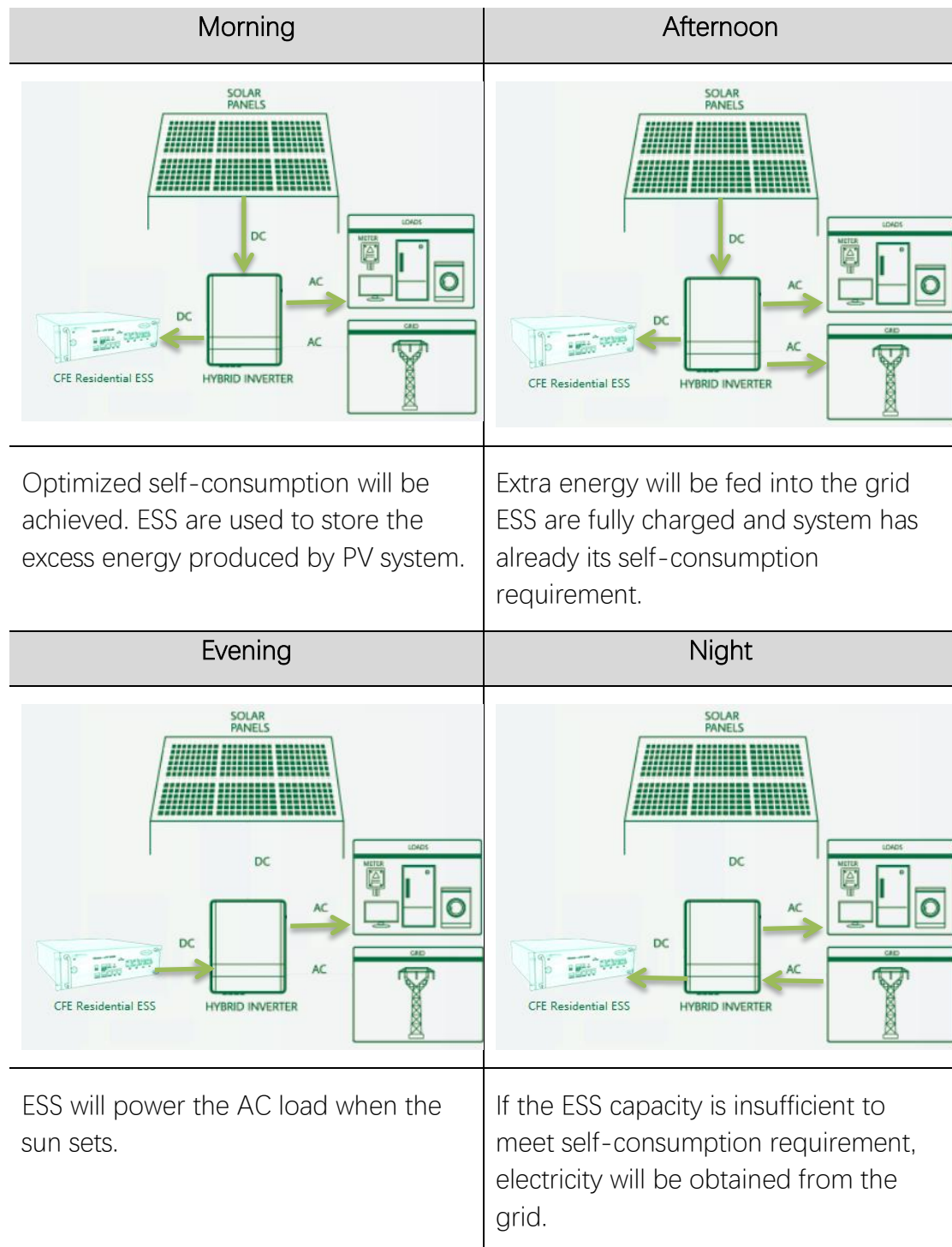

## 2.6 Feature

The CFE Residential ESS has following features:

- ✓ **Energy storage unit:** This battery is suitable for PV solar system compatibility.
- ✓ **Battery management system (BMS):** The battery's built-in BMS monitors prevents the battery from running outside of the design limitations. See **Troubleshooting on Chapter 8.**

- ✓ **Monitor:** The battery's BMS is built-in with WIFI module, the battery running information could be viewed via mobile phone and computer.
- ✓ **Easy firmware update:** The BMS firmware can be updated to the latest version. See **Chapter 9 Firmware Update**.
- ✓ **Expandability:** The battery capacity can be increased by adding another battery. See **part 5.4 cable connections**.

### 3 Guidance for Disconnection of Batteries during Shipment

- 1) Cartons that have been crushed, punctured, or torn in such a way that contents are revealed shall be set aside in an isolated area and inspected by a skilled person. If the package is deemed to be not suitable for shipping, the contents shall be promptly collected, segregated, and either the consignor or consignee contacted.
- 2) The DC circuit of CFE Residential ESS has been disconnected before outgoing.
- 3) A precautionary label had been affixed to the shipping carton to alert individuals as to the battery within the package have been disconnected; otherwise, the battery should not be transported.
- 4) We have conducted comprehensive tests to ensure the equipment they distribute around the world is safe for shipping transport. These products shall be handled with care and immediately inspected if visibly damaged. If the box is visibly damaged, please contact the CFE customer careline to confirm whether the battery could be used safely or not.

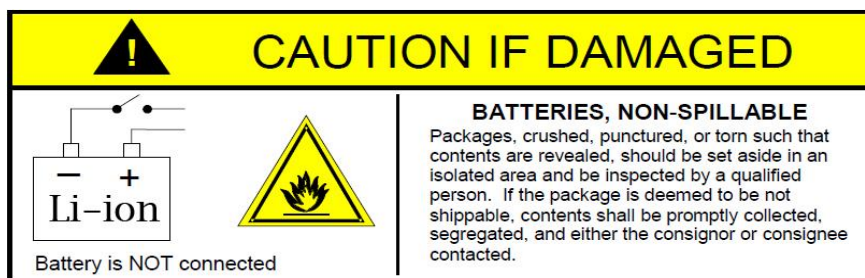

### 4 Installation Prerequisites

#### 4.1 Installation Location

Make sure that the installation location meets the following conditions:

- ✓ The building is designed to withstand earthquakes.
- ✓ Far away from the sea to avoid salt water and humidity.
- ✓ The floor is flat .
- ✓ No flammable or explosive materials nearby.

- ✓ Optimal ambient temperature is between 15°C and 30°C.
- ✓ Temperature and humidity stay at a constant level.
- ✓ Minimal dust and dirt in the area.
- ✓ No corrosive gases present, including ammonia and acid vapor.

The CFE Residential ESS is rated at IP20, so the battery could be installed indoor.

If the ambient temperature is outside the operating range, battery will protect itself by shutting down. The battery optimal operate temperature is 15°C to 30°C. Frequent exposure to severe operating condition would exacerbate the performance and lifetime of the battery.

#### **4.2 Installation Process**

The battery should be installed according to the following flow chart.

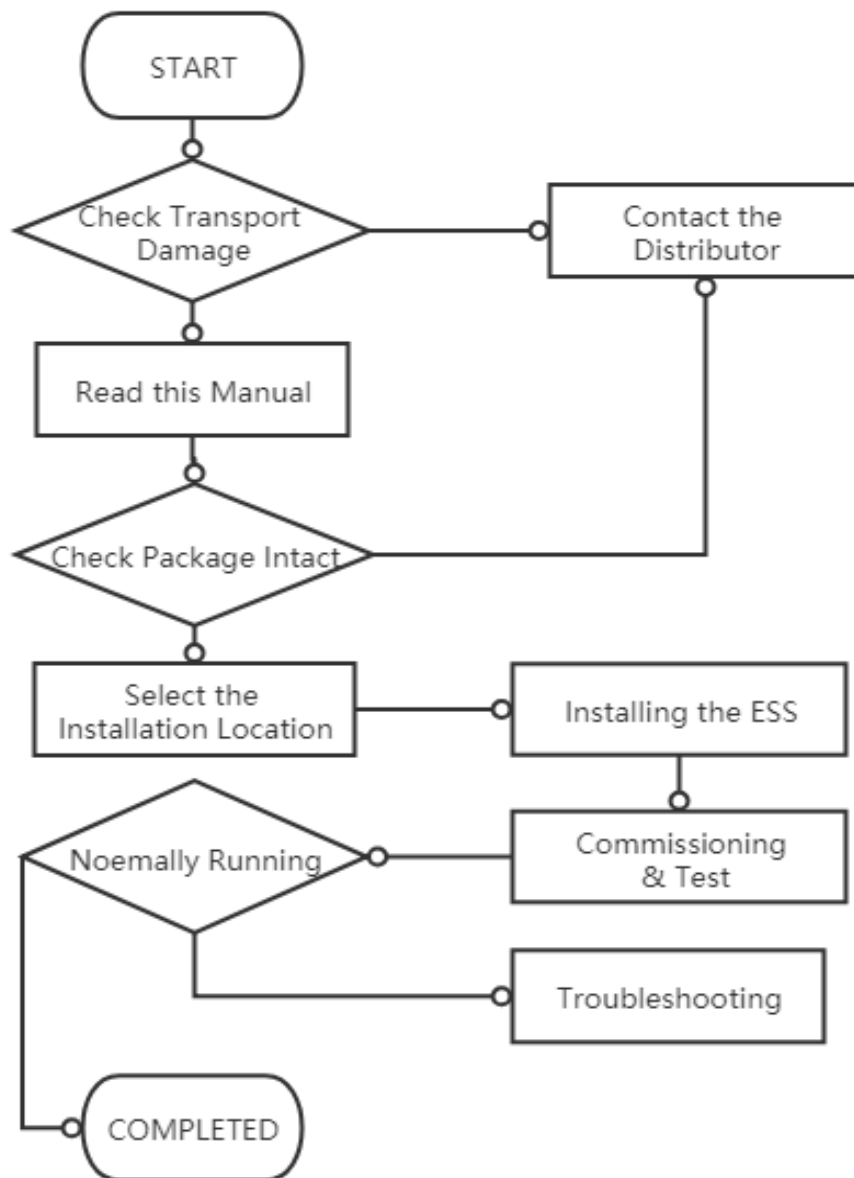

### 4.3 Installation Materials

Following installation materials should be prepared by installers.

- ✓ Power cable
- ✓ Data cable
- ✓ Ground wire
- ✓ Bipolar external isolator, when two or more battery systems in parallel, each of them shall have a bipolar isolator.







#### NOTICE

Make sure that the cross-sectional area of charging cables is 25 to 35 mm<sup>2</sup>.

A breaker between CFE battery and inverter was recommended to install, and the breaker's min. current should meet twice the rated current of the system or following with local regulations.

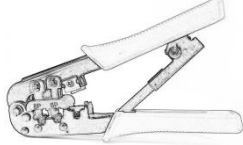
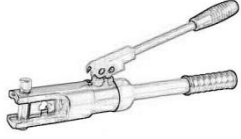
#### 4.4 Tools

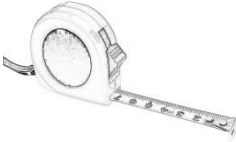
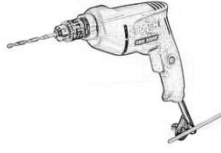
To install the battery pack, those following tools are probably required:

			
Phillips screwdriver	Torque wrench	Cable crimper	Wire clamp
			
Voltmeter	Tape measure	Drill	Flat-head screwdriver

In order to protect operator and installer's safety, please select and use suitable tools and measuring instruments that are certified for precision and accuracy.

#### 4.5 Safety Instruments

When dealing with the battery, following safety gears should be equipped. Installers must meet the relevant requirements of IEC 60364 or the domestic legislation and other relevant international standards.

		
Insulated glove	Safety goggles	Safety shoes

#### 4.6 Network Cable

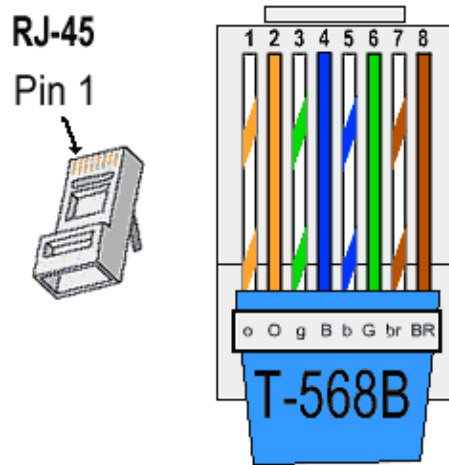

If needed, the network cable should be made like that diagram. But the network cable between battery and Inverter should be made following the definition of Inverter. If available, use a LAN cable tester to check whether the cable is faulty.

#### 4.7 Storage

If the battery is not to be installed immediately or removed from operation and needs to be stored for a long period, please choose an appropriate location to store it. Instructions for storage are:

- ✓ Do not stack more than 8 battery boxes.
- ✓ The temperature of battery stored recommended in the range of  $-20^{\circ}\text{C}$  to  $25^{\circ}\text{C}$ .
- ✓ Do not expose to water

The ESS box should be upright and not stacked upside down when storing the ESS box.

If the ESS needs to be stored over 3 months, the DC circuit of battery should be disconnected. Otherwise, the battery would discharge at a minimum rate and capacity degrades depended on storage time, the battery self-consumption less than 5w. And, if the battery stored over 6 months, it is suggested to connect the battery with inverter and commission the system.

### 5 Battery Installation

#### 5.1 Package Items

These items are included in the package.



Battery\*1                      Cardboard\*1                      User Manual



Warranty                      Battery link\*2                      Data Cable\*1

### 5.2 Checks before Installation

There are a few things to check before installing the battery to ensure that it has no defects.

Check item 1: Check the battery voltage.

#### WARNING

If this checking process is executed for any reason after the battery is fully installed, make sure that the inverter is turned off or break the connection between battery and inverter while checking the battery.



Press and hold the panel button for about 4s and then release it after the two LED lights on, measure the voltage at the terminal interface with a voltmeter. If the voltage is lower than 48 V, do not use the battery and contact CFE customer careline or your distributor.

### 5.3 Installation the battery

#### NOTICE



The symbol located on the front of battery, when connection, the earth wire was must to be installed.

### 5.3.1 Connect with 51.2Vdc Inverter

To prevent the battery from moving, make sure the battery fixed to a wall.

#### NOTICE

If the battery is installed above the floor or on a platform, make sure that the wall or platform is capable of supporting the battery's weight.

#### 5.3.1.1 Wall mounting

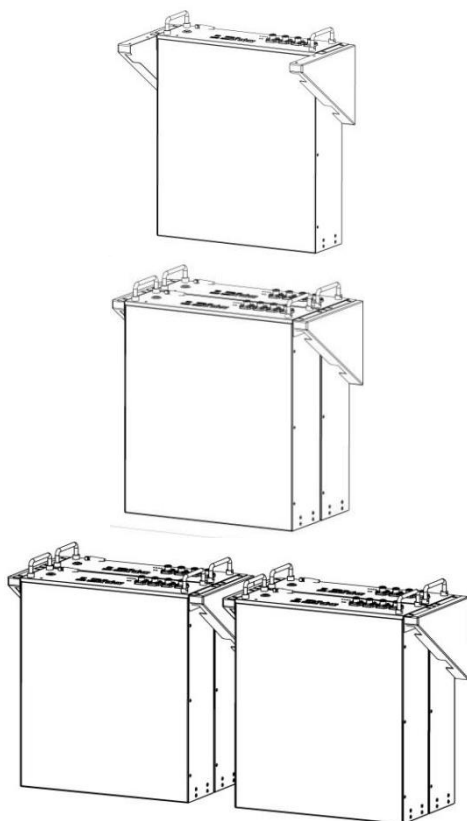
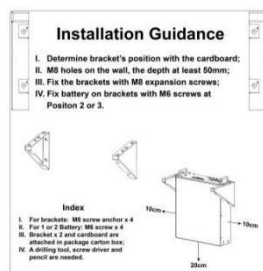

1. Determine bracket mounting place to be fixed using this Positioning cardboard.
2. Drill holes in the wall for the M8 expansion screw anchors, which depth should be at least 50 mm. Tighten the screws to a torque around 2.5 N·m.
3. Fasten the battery to bracket fasten hole with M6 screws with 2.0N·m roughly.
4. Meanwhile, two or four batteries could be installed by these brackets.

Note: if more than 4 batteries installed, a cabinet recommended to be selected for the battery's stable.

The installed location shall be restricted access or installed in a cabinet which provides a guard from pet and children.



### 5.3.1.2 Ground Installation

Meanwhile, CFE-5100 S battery also could be installed on floor, the installation step as following:

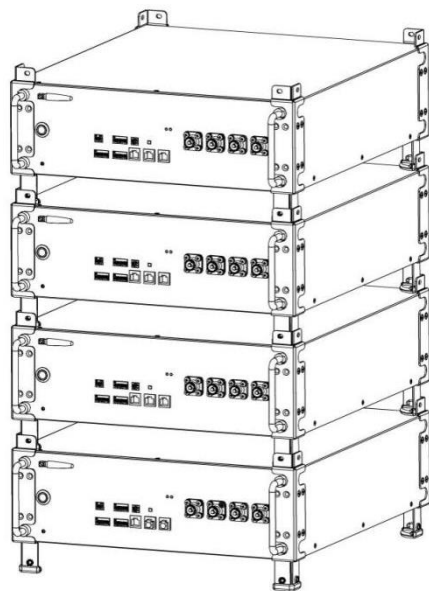
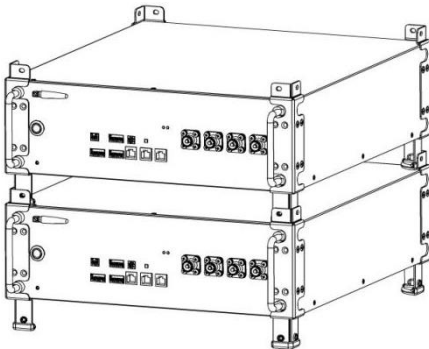
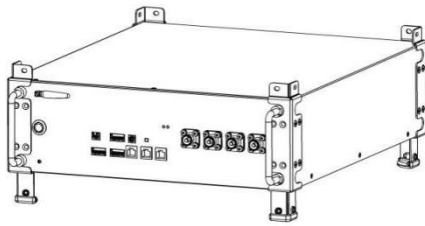
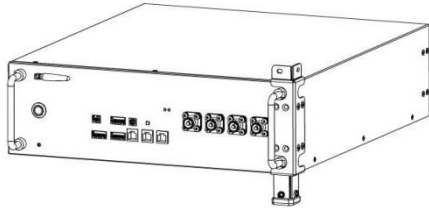

1. Fix the braced feet to battery's mounting holes one by one.
2. If more power and energy needed, 2 to 4 batteries could be installed in one stack.
3. If the number of batteries at the range of 5 to 8, a cabinet recommended to be selected.



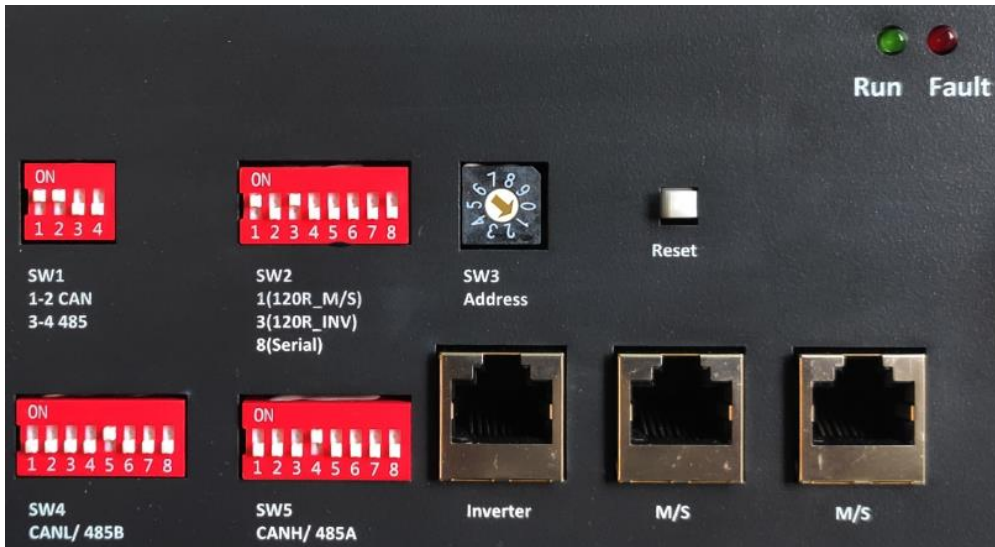























### 5.3.2 Address Selection of Master and Slave Battery(ies) Connection



For Series connection, please make sure the SW2 DIP switch of selected as this type.

**WARNING**

Please make sure the SW2 DIP switch selected correctly, if the battery connected in Parallel mode, but select SW2 DIP8 at ON position, probably lead serious fault even dangerous. Meanwhile, if battery connected in Series mode select SW2 DIP8 at OFF status, serious fault and dangerous probably occurred.

Connected battery number	Group	Set of SW2		Address Set (SW3)
		Series connect	Parallel connect	
1	—	 13	 13	 1
2	Master	 13	 13	 2
	Slave	 18	 1	 1
3	Master	 13	 13	 3
	Slave 1	 8	 0	 1
	Slave 2	 18	 1	 2
4	Master	 13	 13	 4
	Slave 1	 8	 0	 1
	Slave 2	 8	 0	 2

	Slave 3		18		1		3
5	Master		138		13		5
	Slave 1		8		0		1
	Slave 2		8		0		2
	Slave 3		8		0		3
	Slave 4		18		1		4
6	Master		138		13		6
	Slave 1		8		0		1
	Slave 2		8		0		2
	Slave 3		8		0		3
	Slave 4		8		0		4
	Slave 5		18		1		5
7	Master		138		13		7
	Slave 1		8		0		1
	Slave 2		8		0		2
	Slave 3		8		0		3
	Slave 4		8		0		4
	Slave 5		8		0		5
	Slave 6		18		1		6
8	Master		138		13		8
	Slave 1		8		0		1
	Slave 2		8		0		2
	Slave 3		8		0		3
	Slave 4		8		0		4

	Slave 5		8		0		5
	Slave 6		8		0		6
	Slave 7		18		1		7

## 5.4 Cable connections

### WARNING

Before connecting battery with inverter, please make sure that no inverter connected, or the inverter turned off.

### 5.4.1 Cable connection for series connection

#### NOTICE

The voltage difference of each battery should be less than 100mV.

#### 5.4.1.1 Ground installation

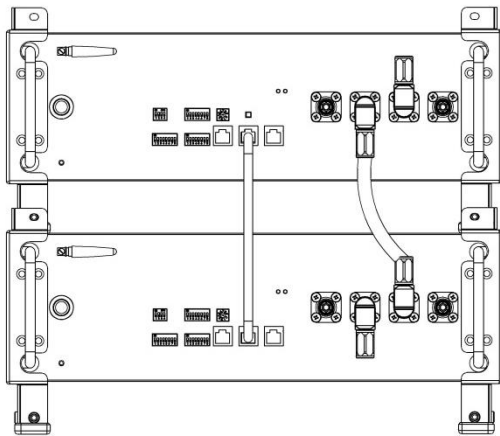

Feed a data cable to M/S communication terminal interface one by one directly.

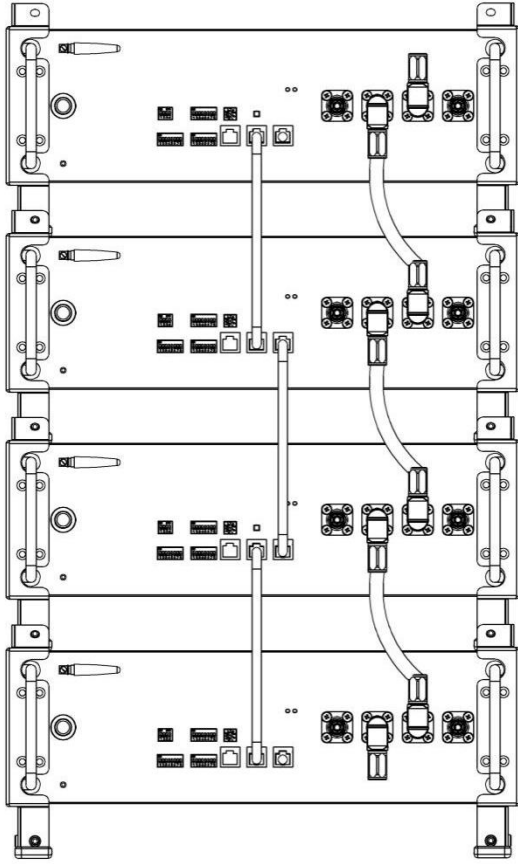

If more than 4 batteries are installed, a cabinet is recommended.

### 5.4.1.2 Wall mounting

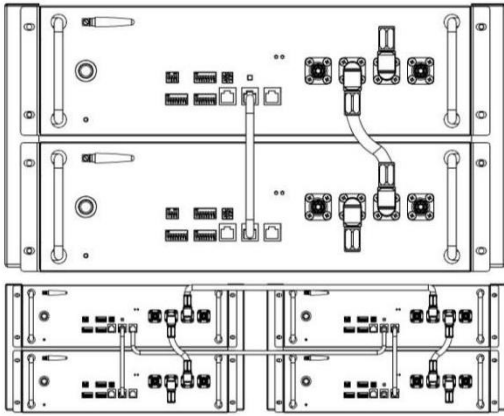

For wall mounting, the battery Series connection number should be less than 4, if more batteries need to be installed, a cabinet is recommended.

#### NOTICE

If battery connected in Series mode, it's better to be installed in Ground installation method, for the Power cable resistance difference between stack and battery pack, which will have fade effect on voltage balance.

### 5.4.2 Cable connection for Parallel connection

#### 5.4.2.1 Ground installation

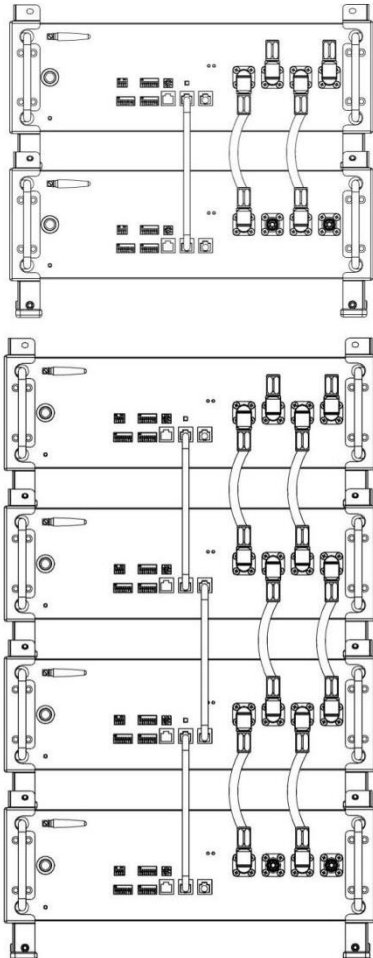

For parallel installation, please pay attention on Cable connection, and the DIP8 of SW2 no need to be changed and stayed on Initial Factory state.

## 5.4.2.2 Wall mounting

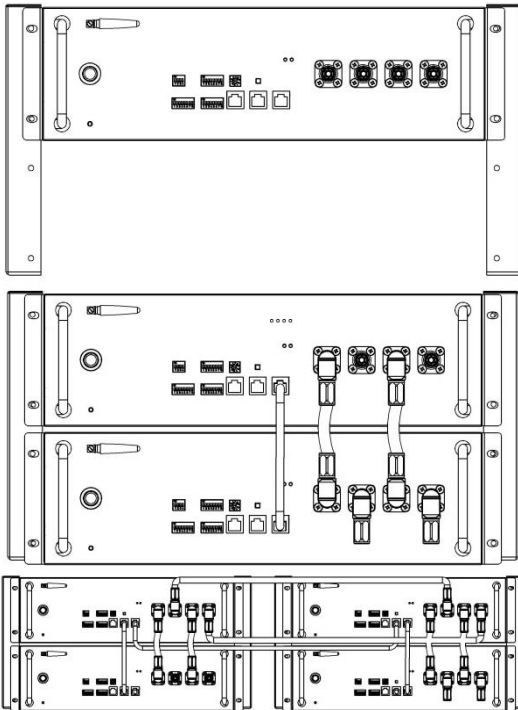

For wall mounting, the battery Series connection number should be less than 4, if more batteries need to be installed, a cabinet is recommended.

### NOTICE

Before two or more batteries installed in parallel, please check the voltage of each battery and make sure the voltage different less than 2.0V.

## 6 Configuration

DIP switch should be set correctly for proper communication between inverter and battery.



If parallel connecting multiple batteries, please set the DIP switches as following:

### 6.1 Configure device WIFI

The CFE Residential ESS has a built-in WIFI module for use with the CFE APP.

The WIFI setting of battery should be as follows:

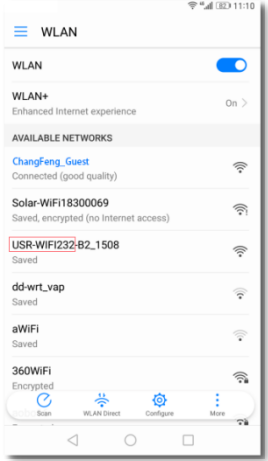

Step		
1	Press and hold the Reset button for 7 seconds.	
2	Connect the 'USR-WIFI232-XX_XXXX' with your smart phone, and then the light of WIFI will turn on by itself within 5 seconds.	
3	Open the APP monitor of battery, select 'Config Device Wifi' option box.	



4 Search and select SSID connected and input the password, press ok and finish. The light of WIFI module would light automatically under WLAN accessible condition.

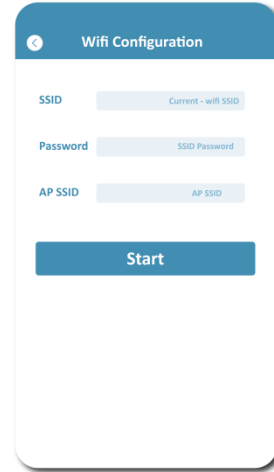

**NOTICE**

If the WIFI cannot be set or there is no WLAN accessible, the battery can still operate normally.

**6.2 Register your account**

**NOTICE**

The CFE Residential ESS could be registered only one time.

Step		
1	Open the APP monitor of battery, select 'Register' option box.	

- 2 After those messages filled and signature, the APP would jump to the running interface automatically.

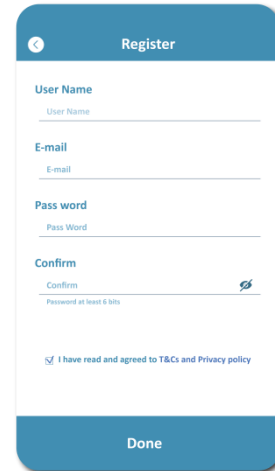

## NOTICE

The CFE Residential ESS running is not associated with registration or not.

### 6.3 Settings for CAN /485 bus pins



Confirm that the CANL/485B DIP switch is set to SW4 which pin is used for CAN low signal by inverter (5-CANL/485B), and the CANH/485A DIP switch is set to SW5 which pin is used for CAN high signal by inverter (4-CANH/485A).

As SW3 the CAN/485 GND/DIP switch, installer should confirm which pin is used for ground by inverter or not.

## NOTICE

The battery default protocol is CAN bus, if an inverter communication mode is RS485 or other protocol, please contact CFE customer careline before installed the battery.

### 7 Commissioning

## 7.1 Commissioning Battery

If there is only one battery installed, use the following steps to operate:

- 1) Press and hold the panel button on the left side of the unit for about 4s, after the indicator lights on, release the panel button.
- 2) Make sure that the Run light is on. If it stays off, do not use the battery and contact CFE or your distributor.
- 3) Turn the inverter on and wait for the start-up sequence to complete fully.

When there are two or more batteries connected with parallel mode, after the charging cable and the data cable has been connected correctly, follow these steps to operate:

- 1) Check battery voltage level is above 48V

If battery voltage is under 48V contact your distributor or CFE after service customer careline for help.

- 2) Press and **HOLD** the panel button for about 4s, after four seconds the indicator lights will turn on.
- 3) Release the panel button.

For all batteries, make sure that the Run light is on.

- a. Make sure the maximum voltage different between batteries less than 2.0V.
  - b. If not, the installer should balance the battery voltage and then parallel connect batteries together.
  - c. Set the DIP switches like part 6-3 Settings for CAN /485 bus pins.
- 4) Turn the inverter on and wait for the start-up sequence to complete fully.

## 7.2 Shutting Down Battery

Shut down the battery only when the battery is no charge or discharge current which could be seen in your smart phone with APP.

- 1) Press and hold the Panel Button about 8s, after a disconnect voice of relay come can release it.
- 2) Make sure that every light on the battery is off.

## 8 Troubleshooting

- 1) Every fault is presented by a fault code. If the battery fault light is on, please check the Fault code in Homepage.

- 2) If the battery fault light on, pls check the Troubleshooting number in Homepage in your CFE APP, if the code is 0x1\*\*\*, this problem would be recovered by itself. But if the code is 0x2\*\*\* or 0x3\*\*\*, please contact the CFE after service customer careline or your distributor for help.
- 3) If the information of battery cannot be seen in the monitoring system, check the battery status first. If the battery status is OFF, please turn the battery on, and then check the WLAN is accessible for battery.
- 4) If Register the battery failure, please check the network of mobile phone nearby the battery installation site available and stable.

Table 8-1 Fault Code of Battery

Fault Code	Detail fault message
0x1001	Battery under voltage warning
0x1002	Battery over voltage warning
0x1003	Battery under temperature warning
0x1004	Battery over temperature warning
0x1005	Battery charge over current warning
0x1006	Battery discharge over current warning
0x1007	Cell over discharge warning
0x1008	Cell over charge warning
0x1009	Battery charge with over temperature warning
0x1010	Battery discharge with over temperature warning
0x1011	Battery charge with under temperature warning
0x1012	Battery discharge with under temperature warning
0x2001	Battery under voltage protect
0x2002	Battery and cell over discharge protect
0x2003	Battery over charge protect
0x2004	Battery over voltage and cell over charge protect
0x2005	Battery under temperature protect
0x2006	Battery over temperature protect
0x2007	Battery charge over current protect
0x2008	Battery discharge over current protect
0x2009	Cell over discharge protect
0x2010	Cell over charge protect
0x3000	Communication broken between master and slave Battery
0x3001	Address select fault

## 9 Firmware Update

It is possible to update the BMS firmware version manually via the WIFI monitor system App.

After a new firmware version is uploaded to the server, the firmware could be updated over the Internet by itself after holder confirmed.

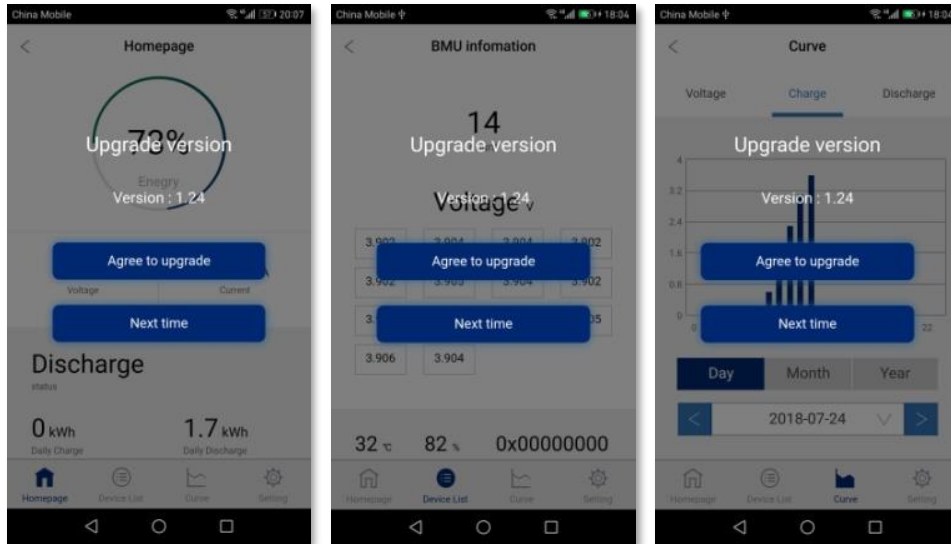



First-class power battery system supplier  
First-class supplier of energy storage and microgrid



Global Exclusive Distributor



### CF ENERGY CO., LTD.

Company Address:

Workshop No.18, Demonstration Base of Traditional Industry  
Transformation, High-tech Zone, Qindu District, Xianyang City,  
Shaanxi Province, PEOPLE'S REPUBLIC OF CHINA

Tel: +86 400 996 8377

Web: [www.cfenergygroup.com](http://www.cfenergygroup.com) E-mail: [sales@cfenergygroup.com](mailto:sales@cfenergygroup.com)

### CNBM INTERNATIONAL CORPORATION

English Language

Felix Wang, Mob/Whatsapp/Wechat: 0086-13717762770

Chris Wu, Mob/Whatsapp/Wechat: 0086-18661316123

Erica Hu, Mob/Whatsapp/Wechat: 0086-15222393724

Adeline Chen, Mob/Whatsapp/Wechat: 0086-18303014060

Jerry Li, Mob/Whatsapp/Wechat: 0086-18800427504

Spanish Language

Silvia Yan, Mob/Whatsapp/Wechat: 0086-15701699087

E-mail: [solar@cnbmsolar.com](mailto:solar@cnbmsolar.com)